

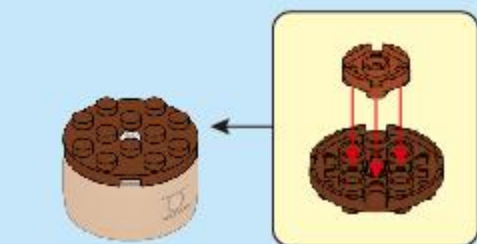

2

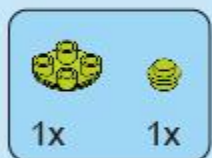

4



6



7

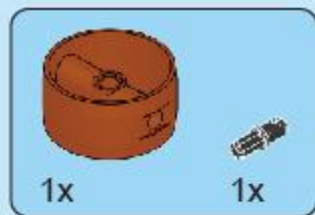

1



3

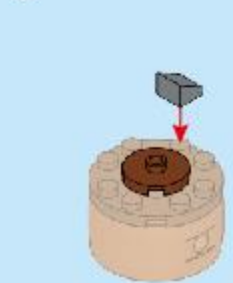

5

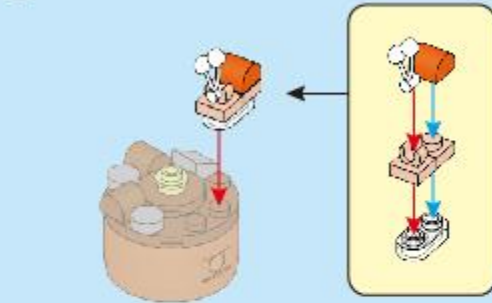

8

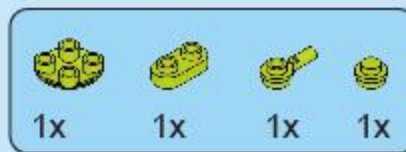
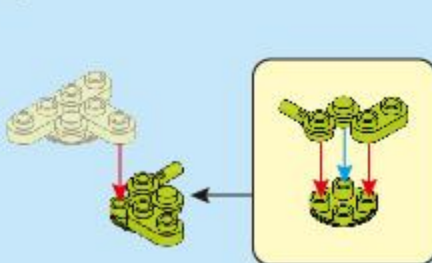

9

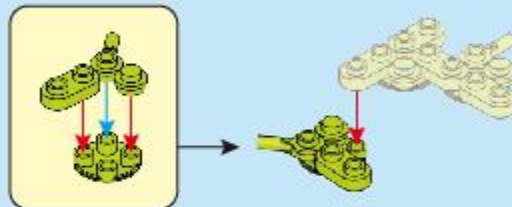

10

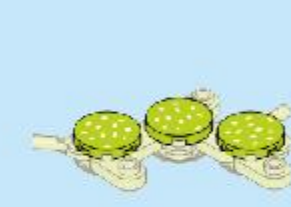

11

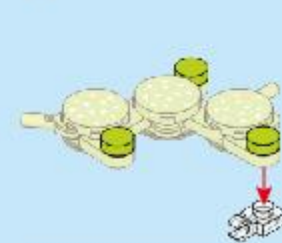

12

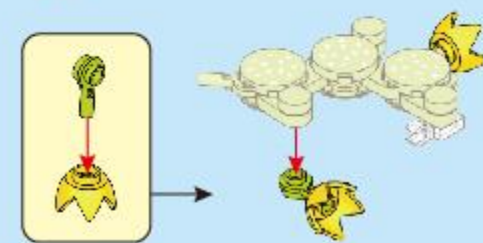

13

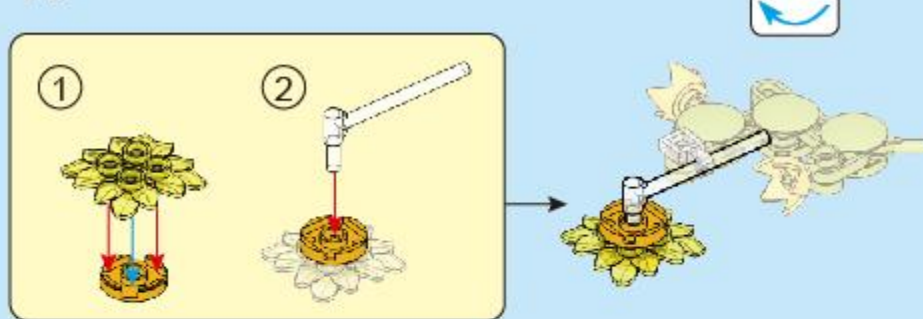

14

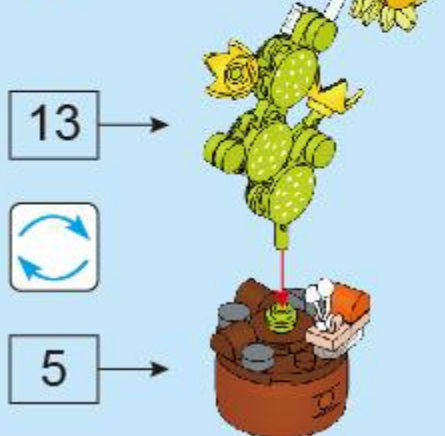

15





1

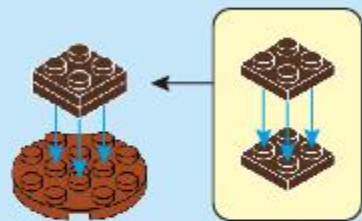

2

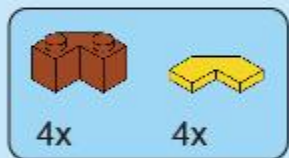

3

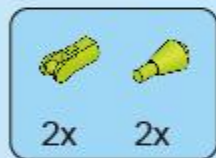
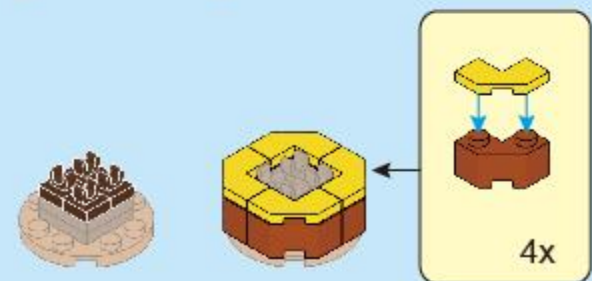

4

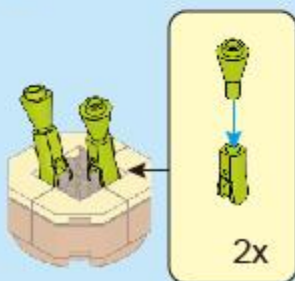

5

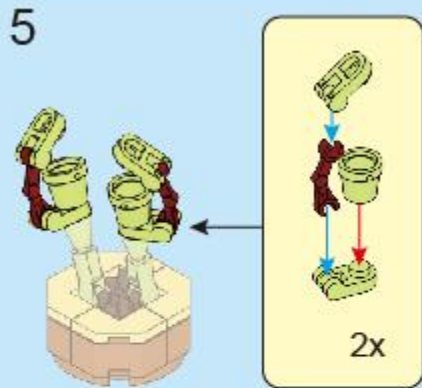

6

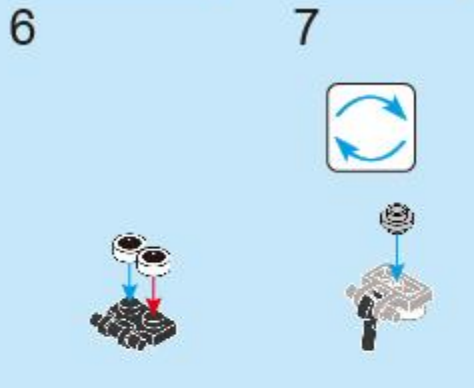

7



8



9

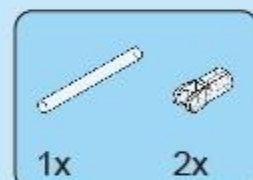

10

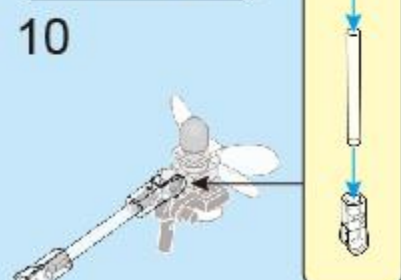

11

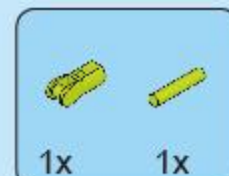
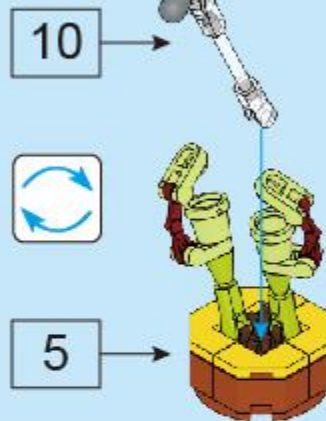

12



13



14

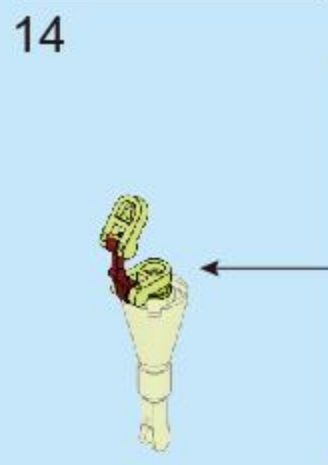

15



16

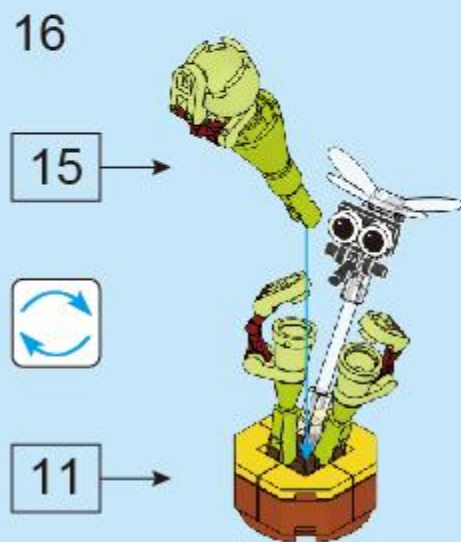

17



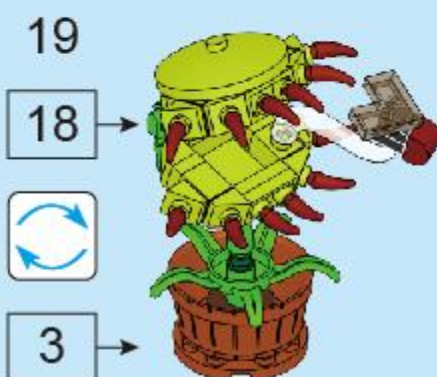
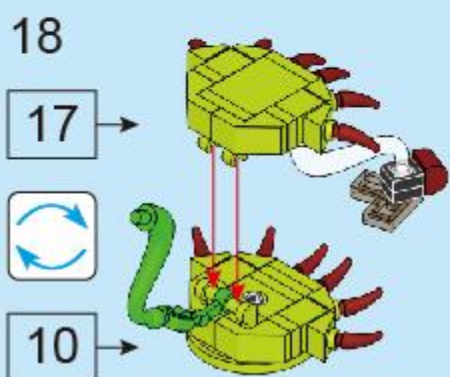
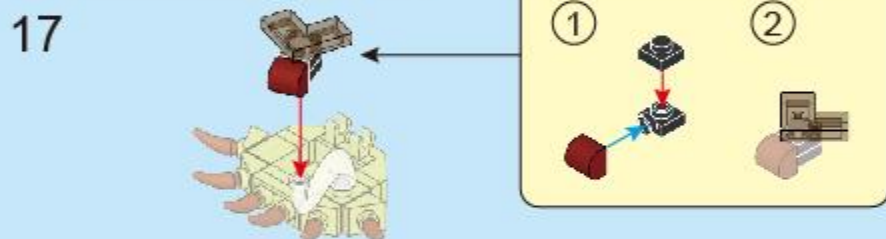
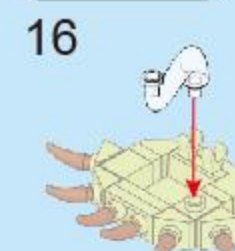
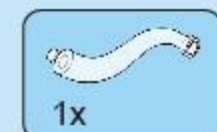
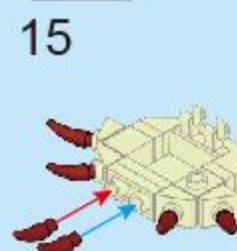
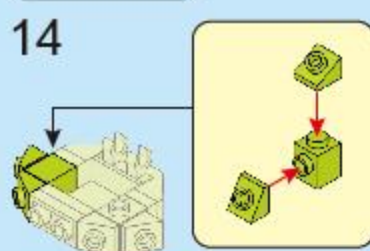
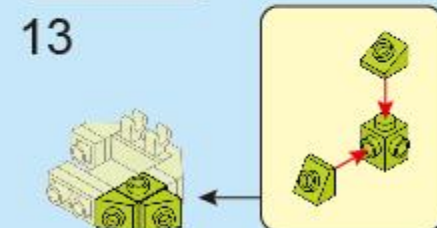
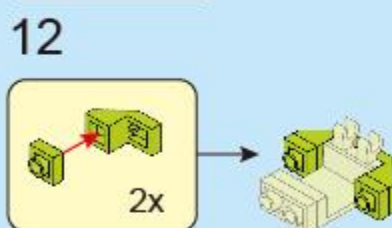
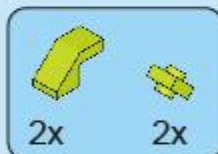
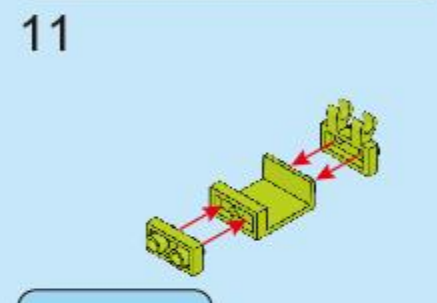
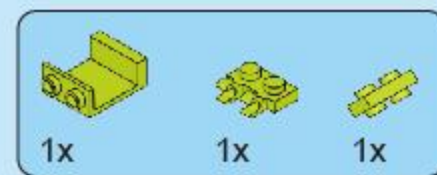
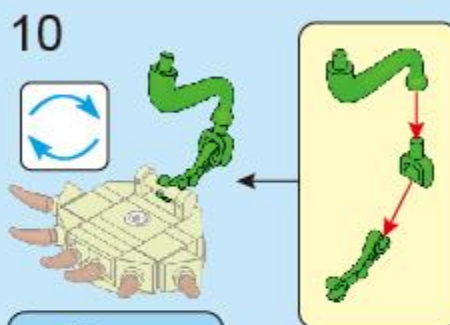
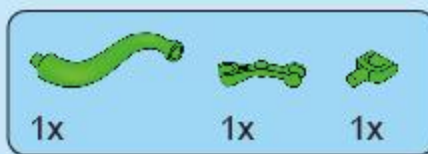
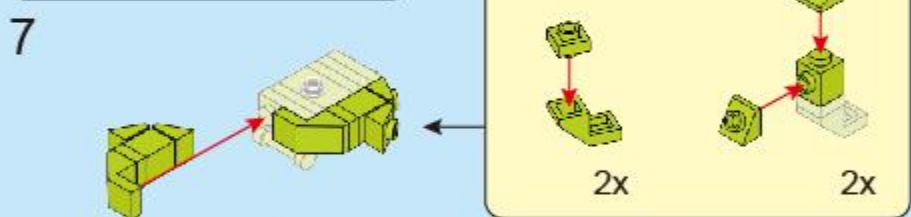
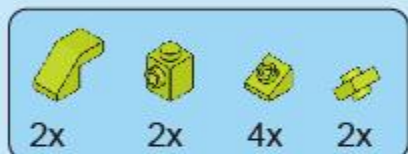
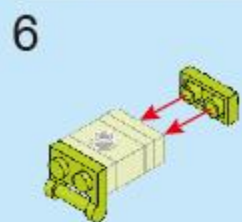
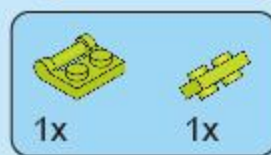
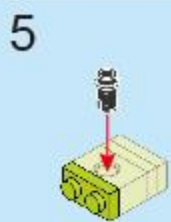
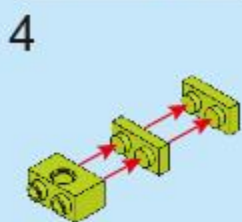
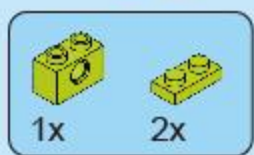
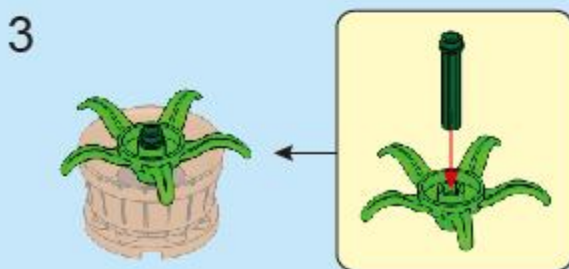
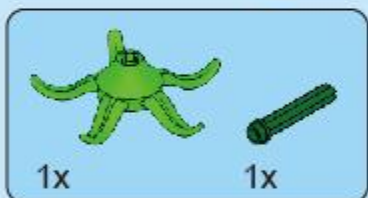
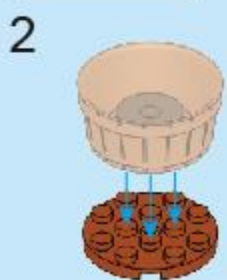
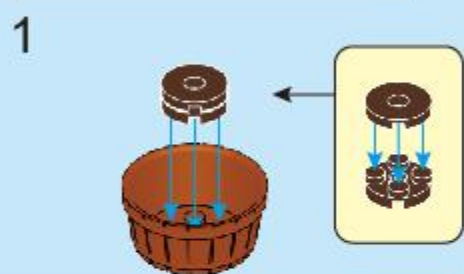

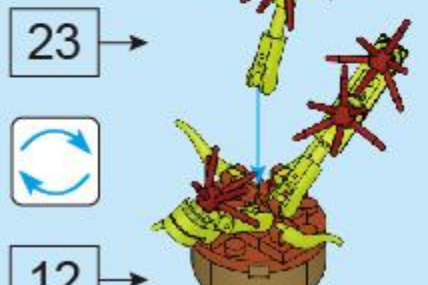
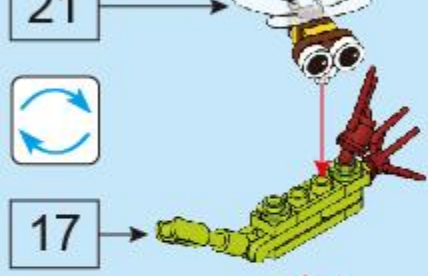
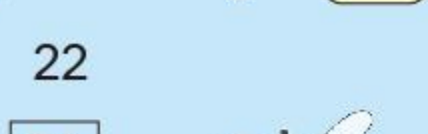
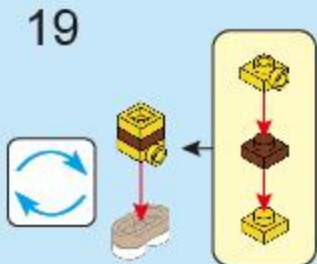
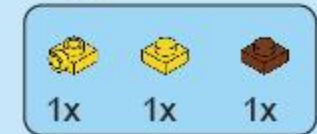
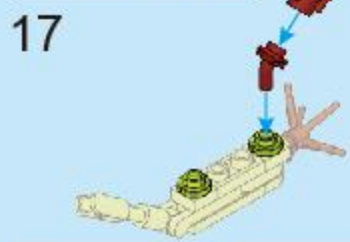
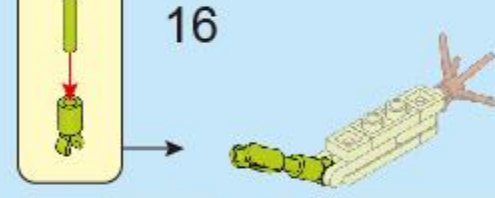
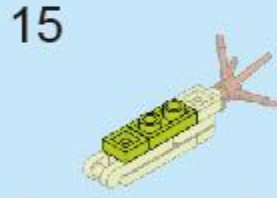
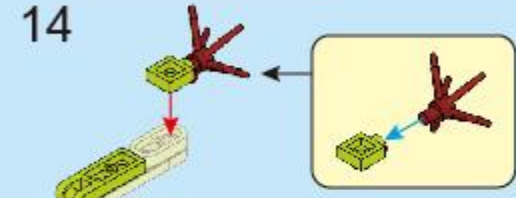
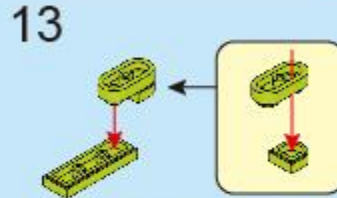
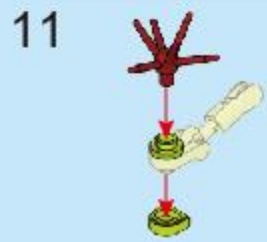
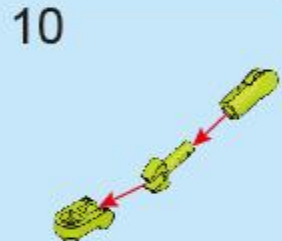
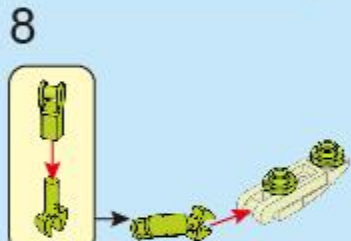
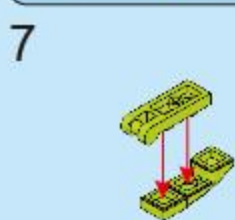
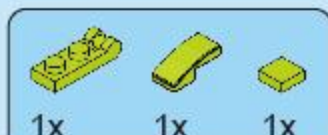
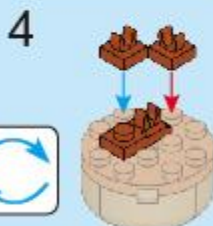
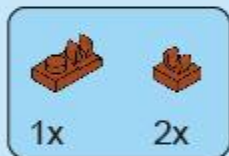
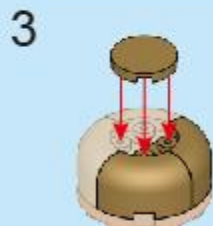
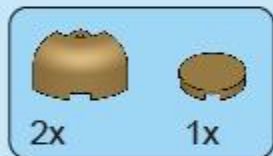
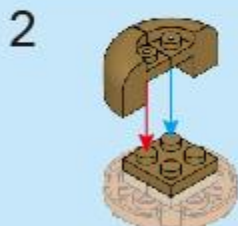

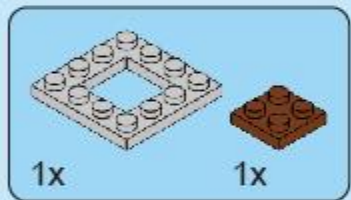

2



5



7

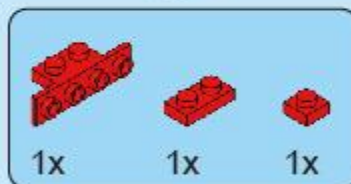

9

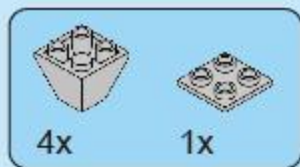
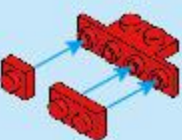

1

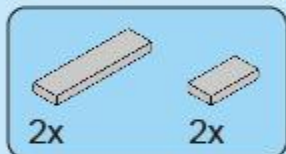
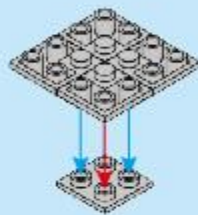

3

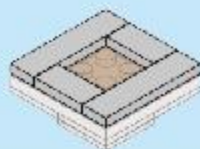

4

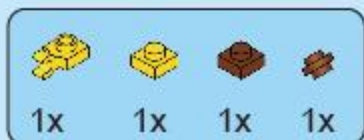

6

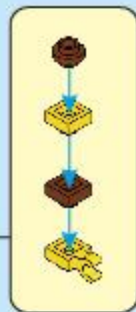

8



10

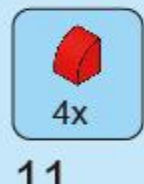
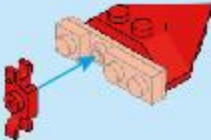

11

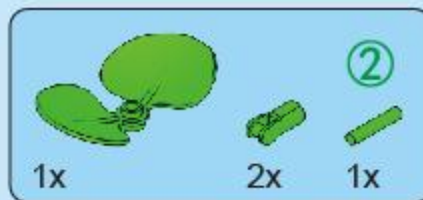
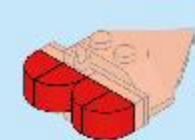

12

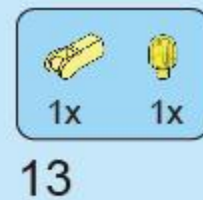
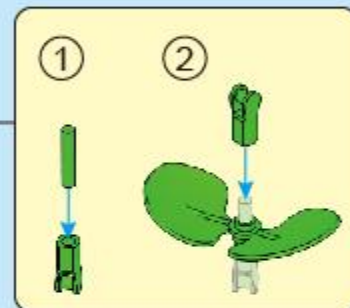
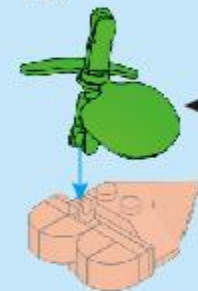

13

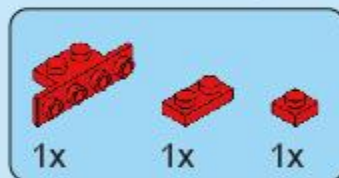
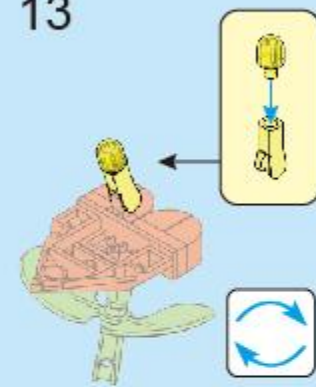

14

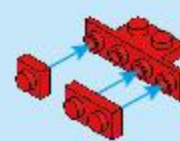

15

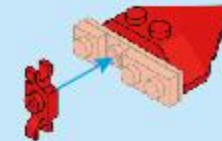

16

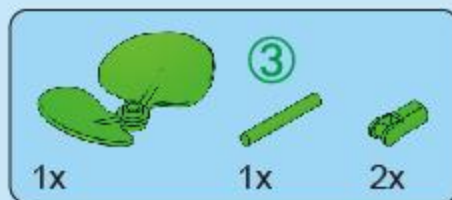
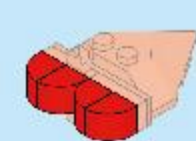

17

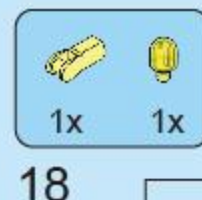
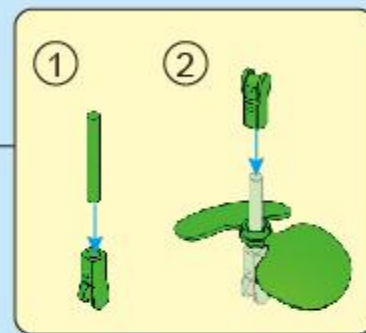

18

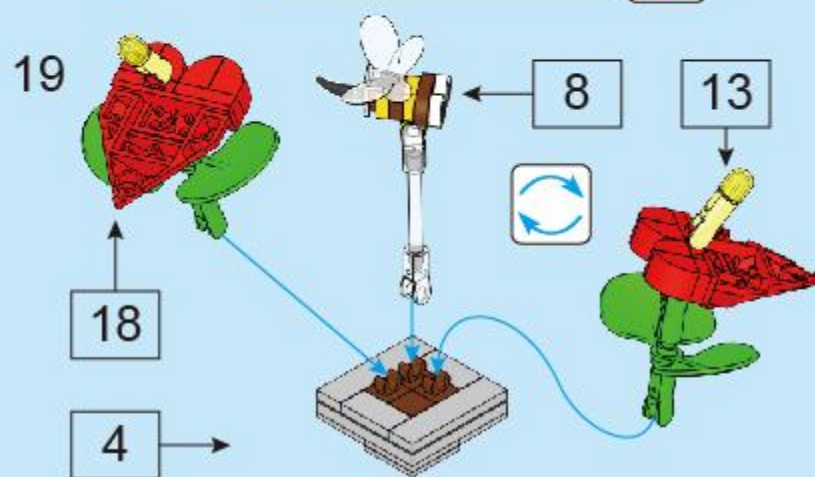





1.09.04.8178.07



1

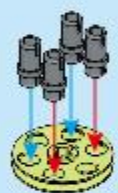

2

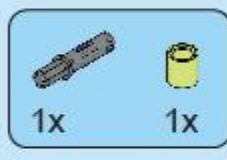

3



4



5



6

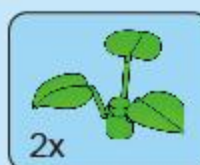

7

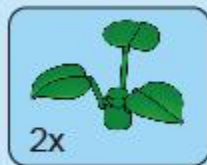

8



9

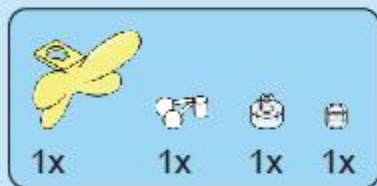

10

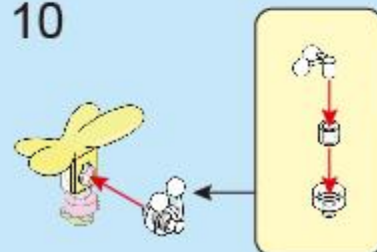

11

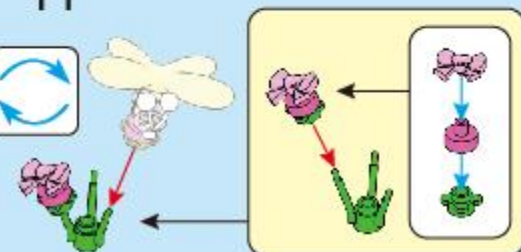

12



13



14

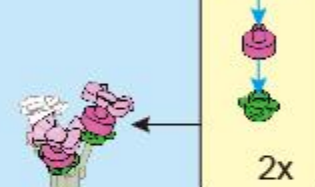

15



16



8



17

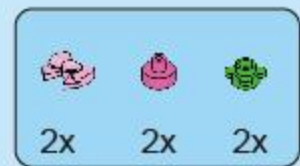

18

19

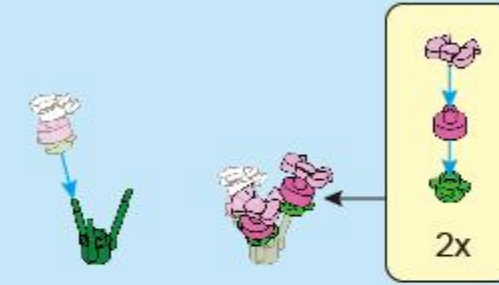

20

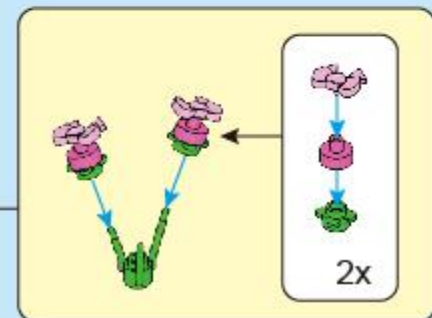

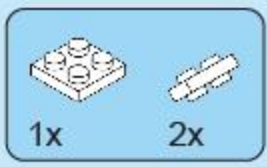

1

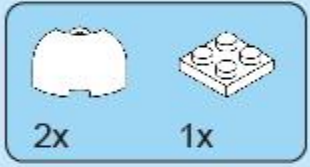
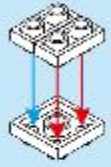

2

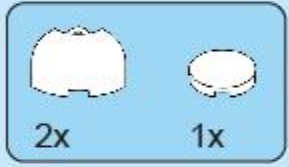

3



4

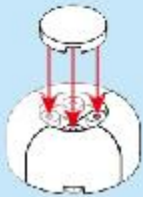
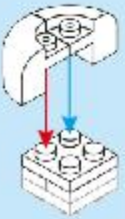

5



6



7

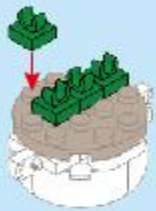

8

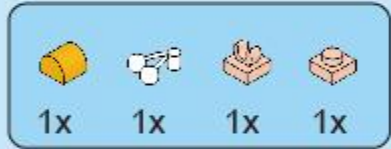

9

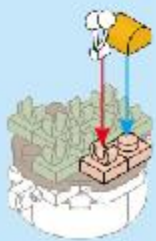

10

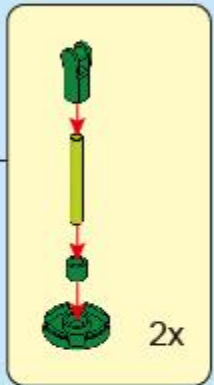
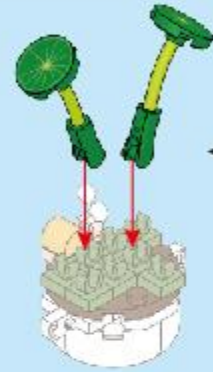

11

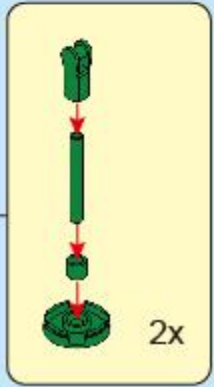

12

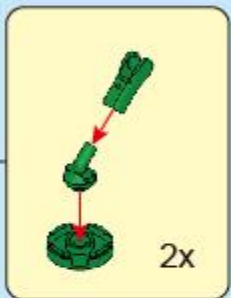

13

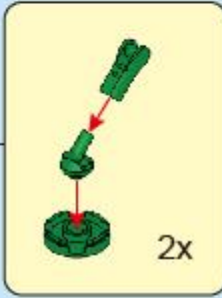

14



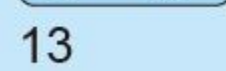
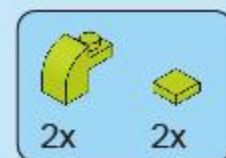
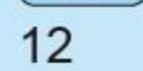
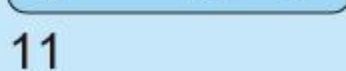
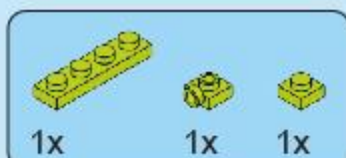
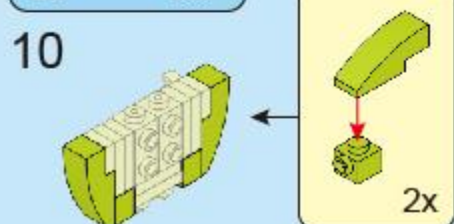
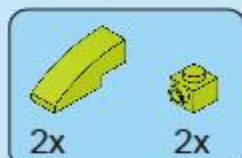
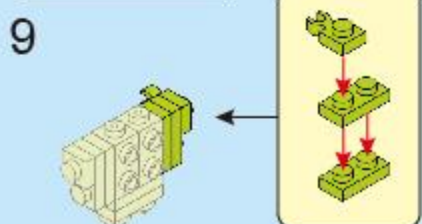
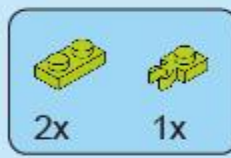
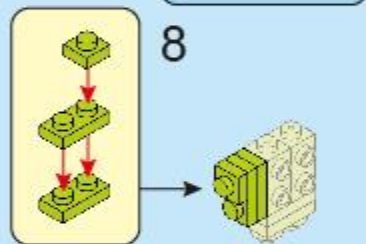
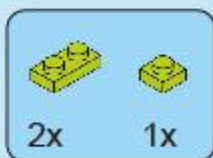
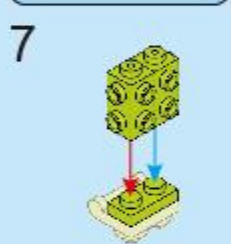
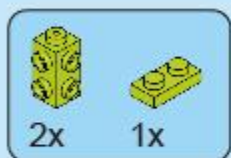
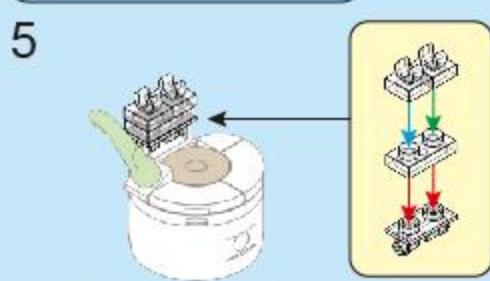
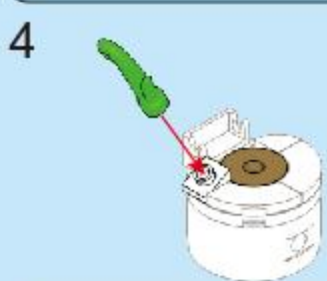
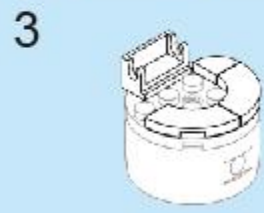
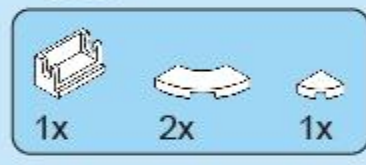
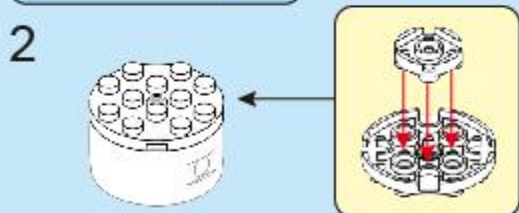
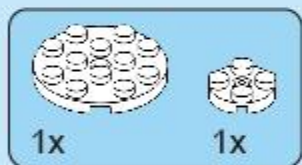
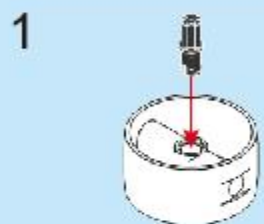
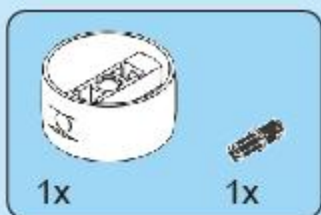

14



15

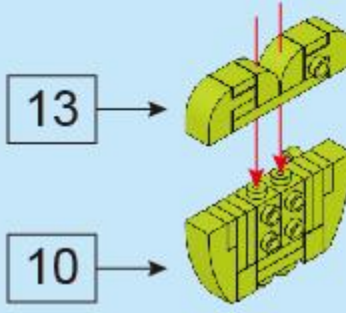
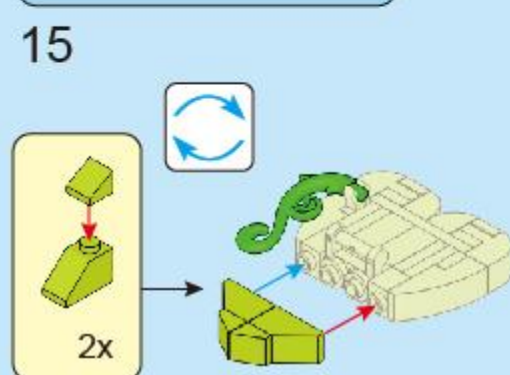
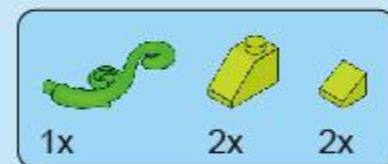

13

10

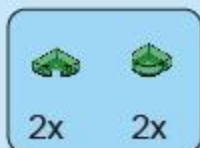

16



17

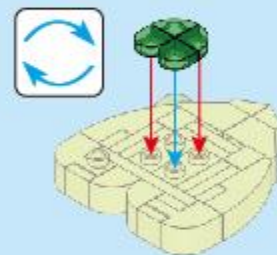

18

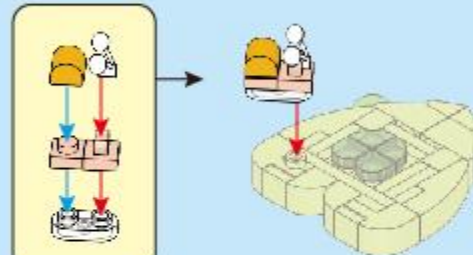

19

17

5

5

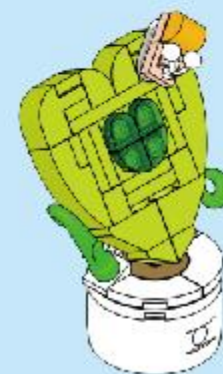
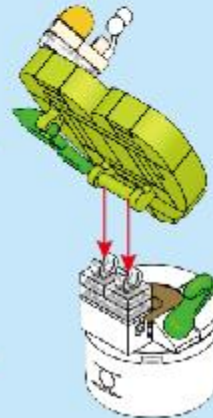

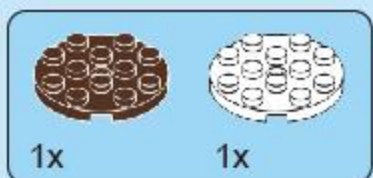

1

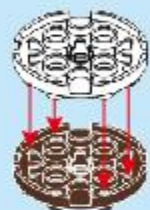

2

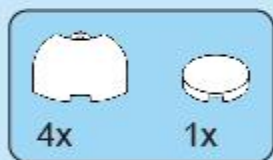
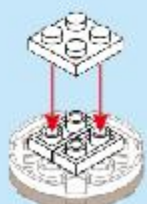

3

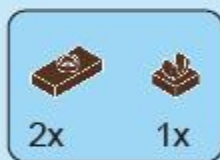
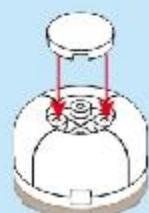

4

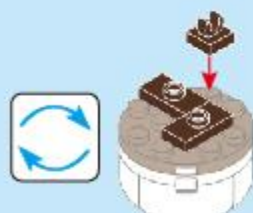

5



6



8

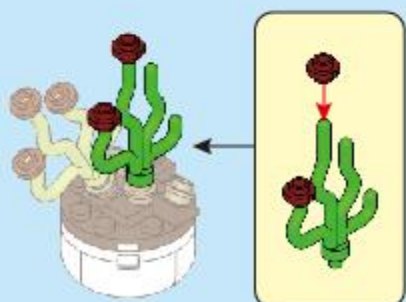

9

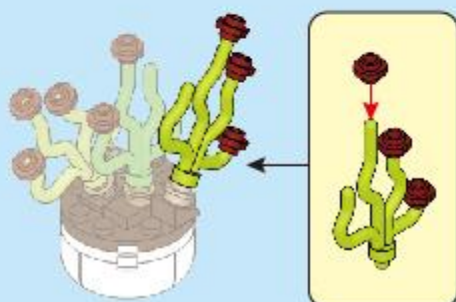

10

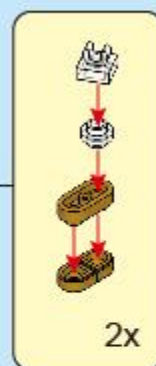
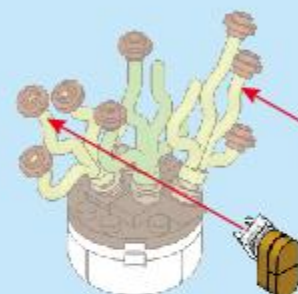

11

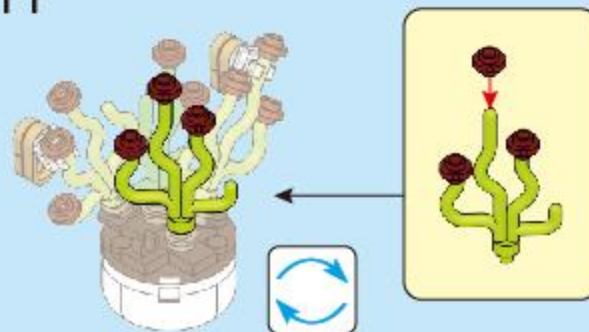

12



13

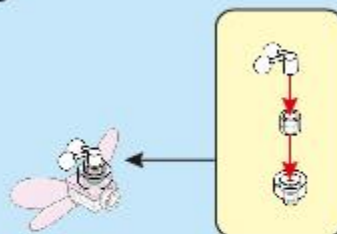

14



15

14 →



11 →

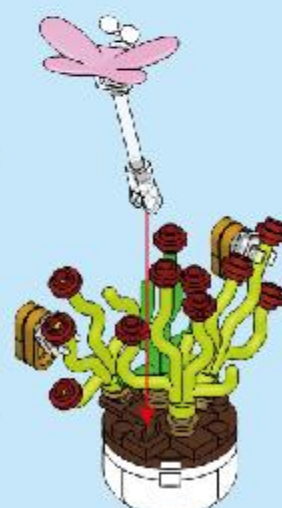

16





1

1x 1x

③

1:1

2

5x

3

6x

4

③

1x 1x



5

1x 1x

6

3x 3x

7

1x 1x

5

7

6

3x

7

8

1x 2x

10

1x 1x 1x 1x

8

7

3

9

1x 2x

12

11

1x 1x

12

1x 2x

13

1x 1x 2x 3x 1x

14

① ②

12

8

③

2x 2x 4x 6x 2x

15

① ②

2x 2x

③

②

1:1

②

1x 1x 1x 2x 1x

16

① ②

17

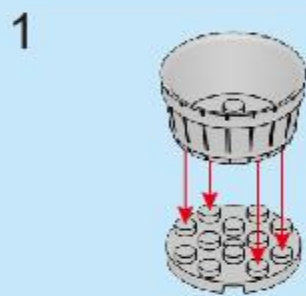
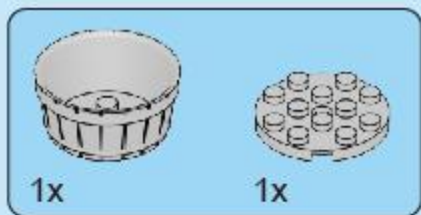

2

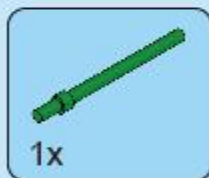
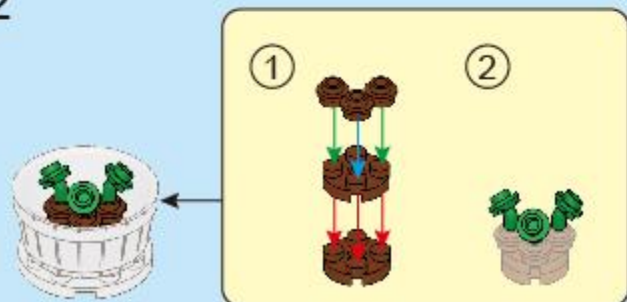

3

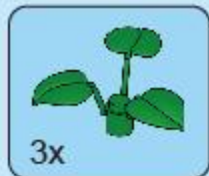

4

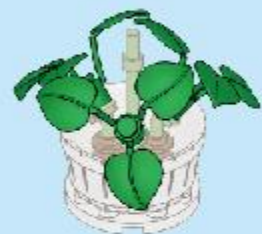

5

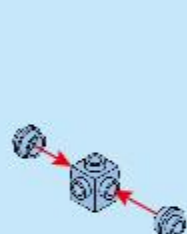

6



7



8

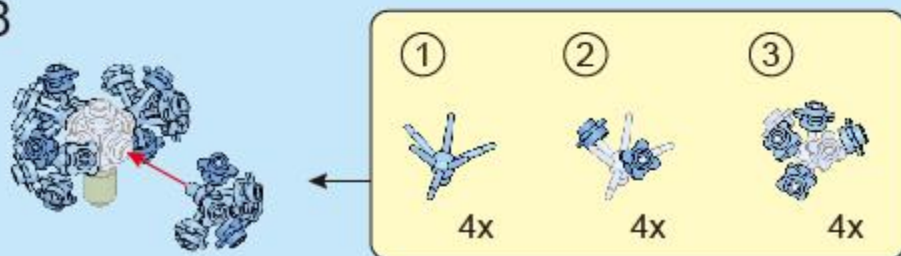

9

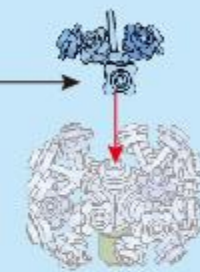
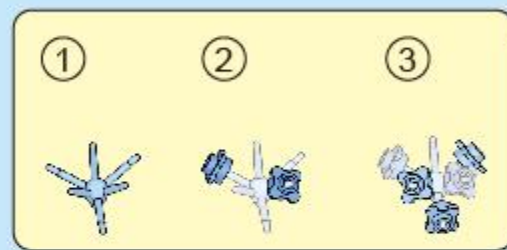

10



11



12

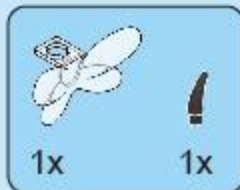
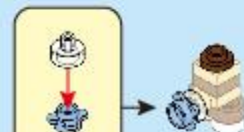

13



14

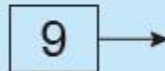
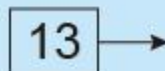

15

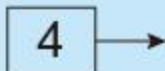

16

